

SK & SKD PURE SINE WAVE INVERTER

600W/700W/1000W/1200W/1500W/2000W/
2500W/3000W/3500W/4000W

USER'S MANUAL

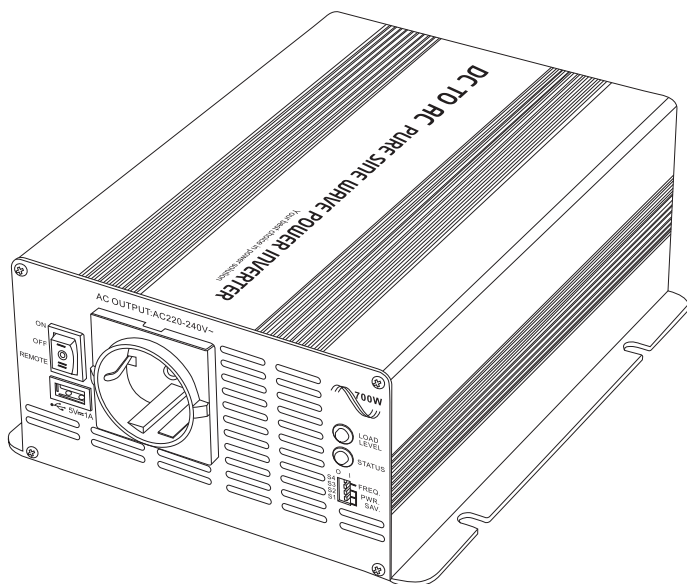

※ THE IMAGE SHOWN HERE IS INDICATIVE ONLY, PLS REFER TO THE ACTUAL PRODUCT.

1. IMPORTANT SAFETY INFORMATION

Warning

Before installing and using the inverter, you need to read the following safety information carefully.

1-1 General safety precautions

1-1-1. Do not expose the inverter to rain, snow, spray, bilge or dust.

To reduce risk of hazard, do not cover or obstruct the ventilation openings. Do not install the inverter in a zero-clearance compartment, over heating may result.

1-1-2. Do avoid a risk of fire and electronic shock. Make sure that existing wiring is in good electrical condition; and that wire size is not undersized. Do not operate the inverter with damaged or substandard wiring.

1-1-3. This equipment contains components which can produce arcs or sparks. To prevent fire or explosion, do not install in compartments containing batteries or flammable materials or in locations where require ignition protected equipment, this includes any space containing gasoline-powered machinery, fuel tanks, or joints, fittings, or other connection between components of the fuel system.

1-2. Precautions when working with batteries

1-2-1. If battery acid contacts skin or clothing, washes immediately with soap and water. If acid enters eye, immediately flood eye with running cold water for at least 20minutes and get medical attention immediately.

1-2-2. Never smoke or allow a spark or flame in vicinity of battery or engine.

1-2-3. Do not drop a metal tool on the battery. The resulting sparks or short-circuits on the battery of other electrical part may cause an explosion.

1-2-4. Remove personal metal items such as rings, bracelets, necklaces, and watches when working with a lead-acid battery. A lead-acid battery produces a short-circuit current high enough to weld a ring or the like to metal, causing a severe burn.

2. FEATURES

- Pure sine wave output (THD < 2%)
- Output frequency: 50/60Hz switch selections
- Input & output completely isolated design
- High efficiency 84-94%
- Capable of driving inductive & capacitive loads at the start moment.
- A LED indicator with twin color displays all operation status.
- Loading and temperature controlled the cooling fan.
- Built in advanced microprocessor to make friendly interface with user.
- Protection: input low voltage alarm & shutdown, overload, short circuit, input over voltage, over temperature, reverse polarity
- USB output port 5V1A

3. Mechanical drawing

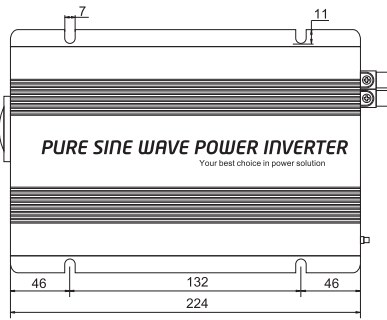
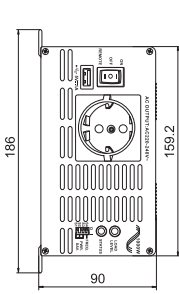

Unit: mm

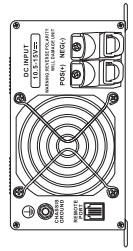

Pure sine wave inverter 600~700W

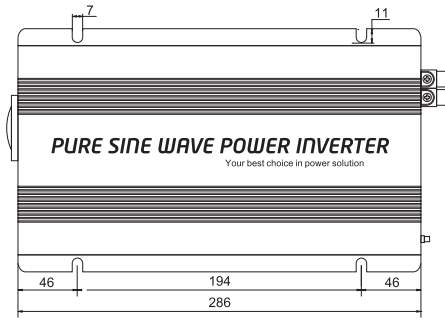
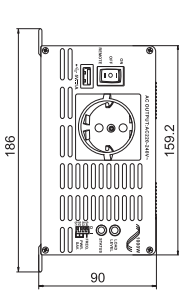

Unit: mm

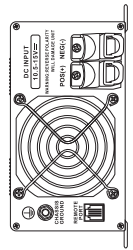

Pure sine wave inverter 1000~1200W

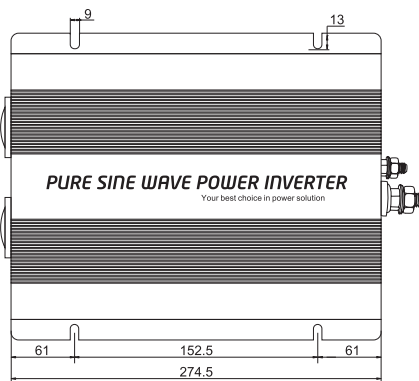
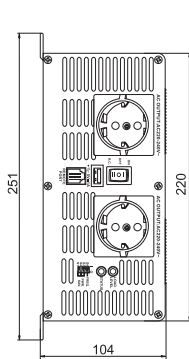

Unit: mm

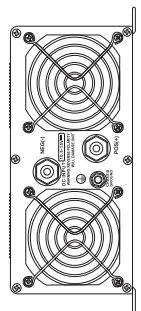

Pure sine wave inverter 1500~2000W

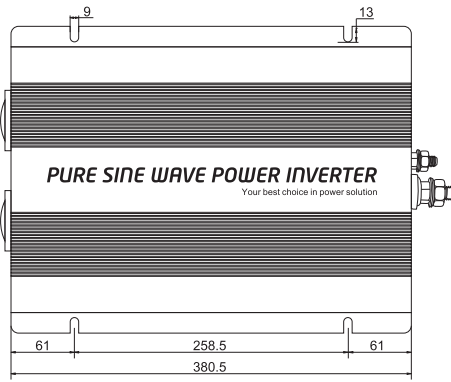
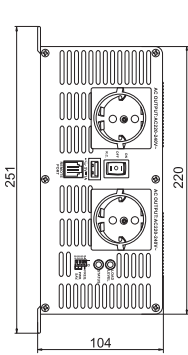

Unit: mm

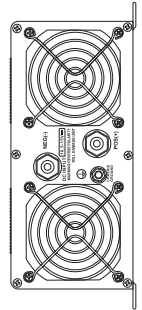

Pure sine wave inverter 2500~3000W

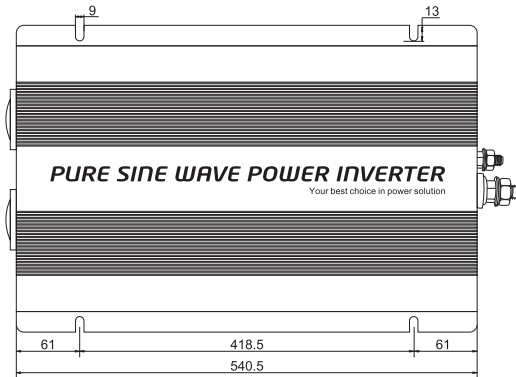
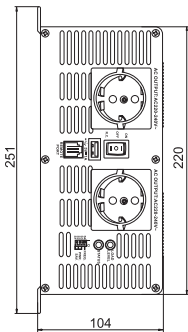

Unit: mm

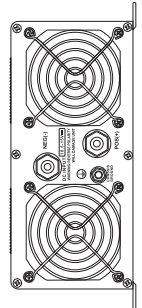

Pure sine wave inverter 3500~4000W

4. INSTRUCTIONS

This power inverter series is the member of the most advanced line of mobile AC power systems available. To get the most out of the power inverter, it must be installed and used properly. Please read the instructions in this manual before installation and operation.

4-1. Front view

Input side

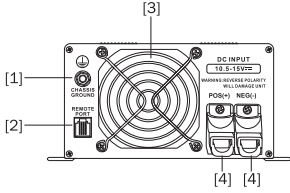

[Pure sine wave inverter 700~1200W]

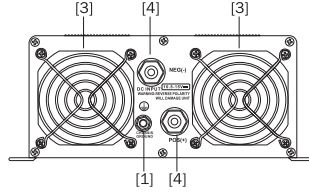

[Pure sine wave inverter 1500~4000W]

- [1] Chassis ground; [2] Remote control port;
 [3] Cooling fan; [4] Input battery connectors (red +) (black -)

Output side

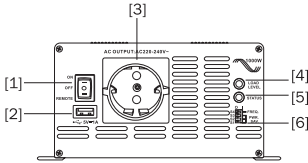

[Pure sine wave inverter 700~1200W]

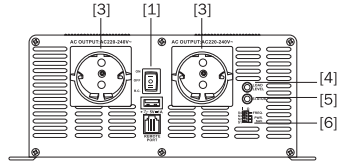

[Pure sine wave inverter 1500~4000W]

- [1] Main Switch [2] USB output port [3] Output outlets
 [4] Load level indicator [5] Status indicator [6] Dip switch setting

LED digital display (For SKD series only)

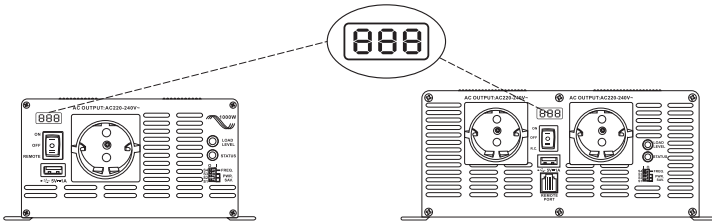

It display the output voltage and output power continuously

4-2. Dip switch

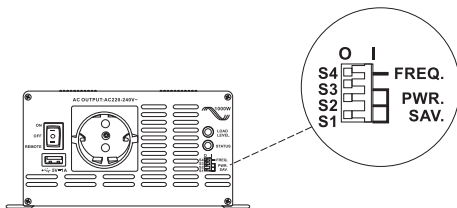

Dip switch	Setting	
S4	O: 50Hz	I: 60Hz
S3	O: OFF	I: 15% loading power
S2	O: OFF	I: 10% loading power
S1	O: OFF	I: 5% loading power

4-3. LED indicators

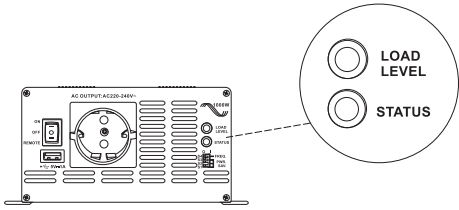

Load level	<20% - off
	between 20% and 50% - green
	between 50% and 90% - orange
	>90% - red
Status	Power on- green
	Failure / protection- red

4-4. Main switch

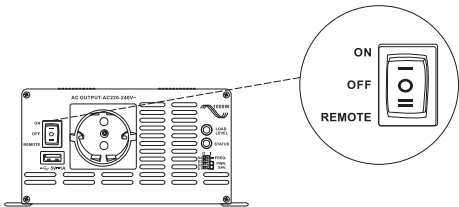

ON	Power on the inverter
OFF	Power off the inverter
Remote	Setting the inverter to control by remote controller

Notes:

- 4-4-1: Before installing the inverter, make sure the main switch must be " OFF".
- 4-4-2: Before using the remote unit, make sure the main switch must be " Remote".
- 4-4-3: Ensure the remote control contact is off

4-5. Output outlets (optional)

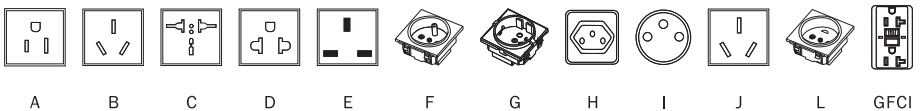

4-6. DC input terminals:

Connect to 12V/24V/48V battery or the other power sources. (+) is positive, (-) is negative. Reverse polarity connection will blow internal fuse and may damage inverter permanently.

Model	DC input voltage	
	Minimum	Maximum
12V	10.5V	15V
24V	21V	30V
48V	42V	60V

4-7. Protections features

Model	DC input (VDC)				Over temperature protection	
	Over voltage	Under voltage alarm	Under voltage		Shutdown	Restart
	Shutdown		Shutdown	Restart		
12V	16V	11V	<10.5V	12.5V	55°C	45°C
24V	32V	22V	<21V	25V		
48V	64V	44V	<42V	50V		

Note: the specifications are subject to change without notice.

5. MAKING DC WIRING CONNECTIONS

Follow this procedure to connect the battery cables to the DC input terminals of the inverter. Your cable should be as short as possible (ideally to use factory spare cables) enough to handle the required current in accordance with the electrical codes or regulations application. Cables are not an adequate gauge(too narrow) or too long will decrease the inverter performances such as poor surge capability and low input voltage warnings frequently and shutdowns. UVP warning presents due to DC voltage drop across the cables from the inverter to the batteries.

The longer or narrower the cables, the greater the voltage drop.

Increasing your DC cable size will help improve the situation.

 **Warning** The installation of a fuse must be on positive cable. Failure to place a fuse on “+” cables running between the inverter and battery may cause damage to the inverter and will void warranty.

6. INVERTER OPERATION

To operate the power inverter, turn the main switch ON, the power inverter is now ready to deliver AC power to your loads. If there is several loads use, turn them on separately after the inverter has been “ON” in order to prevent the OVP present caused by the surge power.

6-1: Set the power switch to the “ON” position and the buzzer will send out “Beep” sounds at the moment the inverter will do self-diagnosis, then the power status LED indicators will also appear various colors, finally the buzzer will sound another” Beep” and the power status LED indicators will turn to” green” color, the inverter starts working successfully.

6-2: Set the power switch to the OFF position, the inverter stops and all the lights that are on, go off.

6-3: Set power inverter switch to the ON position and turn the test load on. The inverter should supply power to the load. If you plan accurately measure the true output r.m.s. voltage of inverter, a meter such as FLUKE 45 BECKMAN 4410 or TRIPLETT 4200 must be used.

7. TROUBLE SHOOTING

 **Warning** Do not open or disassemble the inverter. Attempting to service the unit yourself may result in a risk of electrical shock or fire.

Problems and symptoms	Possible cause	Solutions
No AC power output and Status illuminates the red LED	Over input voltage(OVP)	Check input voltage, reduce input voltage
	Low input voltage (UVP)	Recharge battery, check connections and cable.
	Thermal shutdown (OTP)	Improve ventilation. Make sure ventilation openings in inverter are not obstructed. Reduce ambient temperature.
	Short circuit or wiring error. Over load(OLP)	Check AC wiring for short circuit. Reduce load.

8. MAINTENANCE

Very little maintenance is required to keep your inverter operating properly. You should clean the exterior of the unit periodically with a damp cloth to prevent accumulation of dust and dirt.

At the same time, tighten the screws on the DC input terminals.

9. WARRANTY

We warrant this product against defects in materials and workmanship for a period of 24 months from the date of purchase and will repair or replace any defective power inverter when directly returned, postage paid, to us. This warranty will be considered void if the unit has suffered any obvious physical damage or alteration either internally or externally and does not cover damage arising from improper use such as plugging the unit into an unsuitable power sources attempts to operate products with excessive power consumption requirements, or use in unsuitable environments. This is the only warranty that the company makes. No other warranties express or imply including warranties of merchantability and fitness for a particular purpose.

Repair and replacement are your sole remedies and the company shall not be liable for damages, whether direct, incidental, and special or consequential, even though caused by negligence or other fault.



Tips: The picture and function description just for reference, and we reserve the right to change it and have no notice.